

Data Sheet



Article number: 339710130000

Description: Multibeam 6 Coupling 710.13.0000
Acetal & set screw hubs

Measures

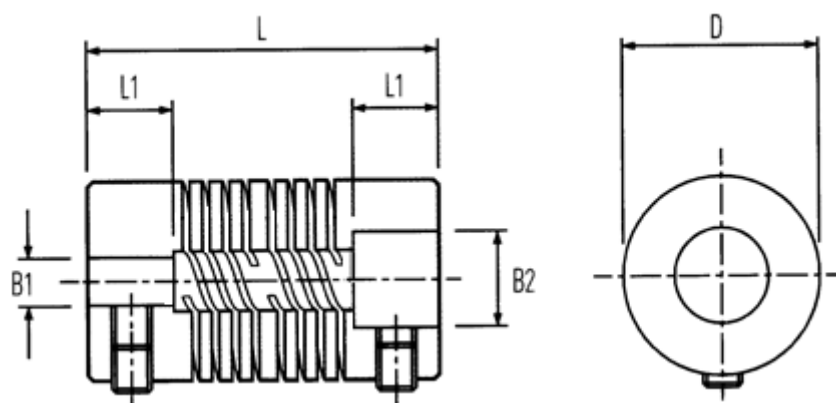

B1: Pre-drilled	= 3.0	Peak Torque NM = 0.51
B2: Pre-drilled	= 5.00	Set Screw = M3
D	= 12.7	
L	= 22.9	
L1	= 6.5	
Max angular displacement	= 0.17	
Max B1 & B2	= 6.00	
Max parallel displacement	= 5	